



POLYWOOD

Assembly Instructions



Having Trouble?

If you have questions or concerns regarding assembly instructions or missing parts, please contact us at **(833) 665-6300** or email support@polywoodoutdoor.com



Share your space

We love to see where our furniture ends up — snap a pic and share it on Instagram or Facebook!
#polywood



Watch & Learn

For assembly videos and more, visit [youtube.com/polywood](https://www.youtube.com/polywood)

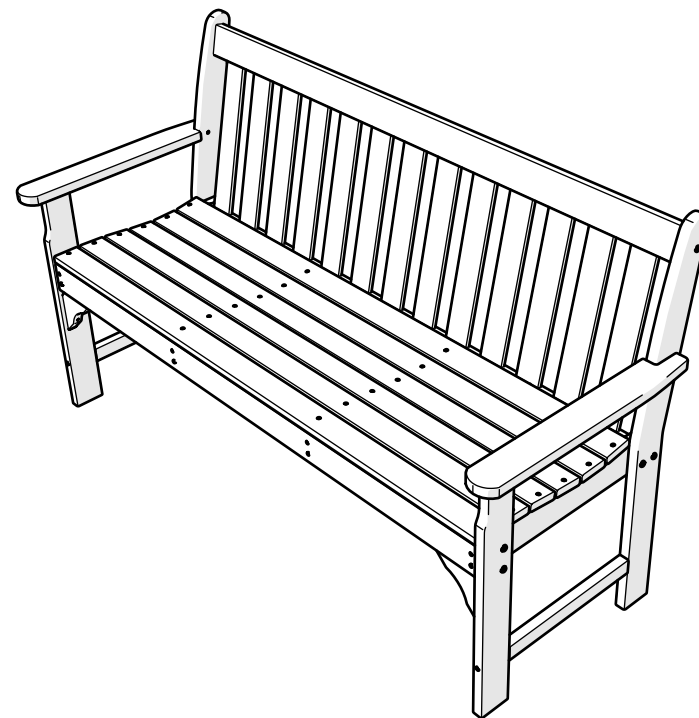

GNB60 Vineyard 60" Bench

20-Year Warranty

To view our full warranty, please visit polywoodoutdoor.com/warranty

Easily register your product using one of the methods below:

Text POLYWOOD to 71403
Receive a link to register online

— or —

Register on our website
register.polywoodoutdoor.com

— or —

Send a Picture
Take a photo of the icon below and text it to 71403 (US only)

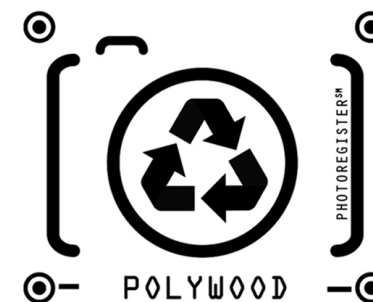

Cleaning Tips

Even POLYWOOD gets dirty — here are some ways to help keep it clean:

For a quick clean:

Simply wipe down with soap and water.

For a deeper clean:

You'll need:

- » 1/3 bleach and 2/3 water solution
- » clean cloth
- » soft bristle brush

Wipe on solution with your cloth and let it sit on the lumber for a few minutes (this will not affect the color). Then, loosen any dirt and debris that may catch in surface grooves with a soft bristle brush; hose down to rinse.

TOOLS

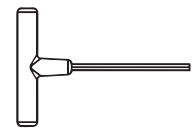

4mm T-handle hex key (included)

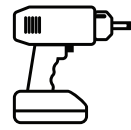

Phillips Screwdriver
(Screw Gun Recommended)
(Not Included)

PARTS

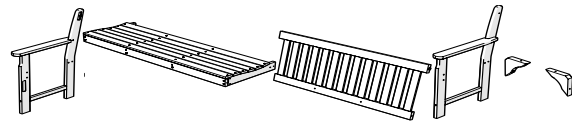

A x6

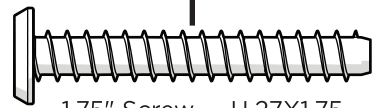

1.75" Screw — H.27X1.75

B x2

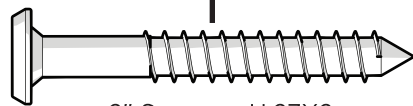

2" Screw — H.27X2

C x2

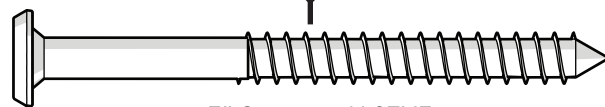

3" Screw — H.27X3

D x4



2" Phillips Screw — H8X2

E x2



1.75" Bolt — H.25-20X1.75

Something missing?
Call (833) 665-6300

1

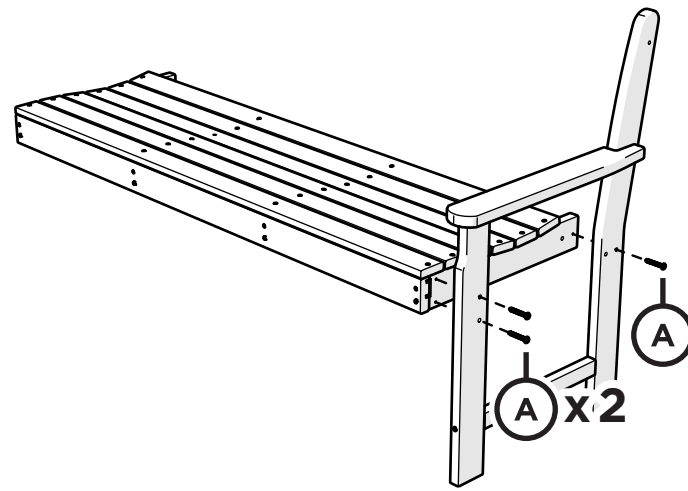

2

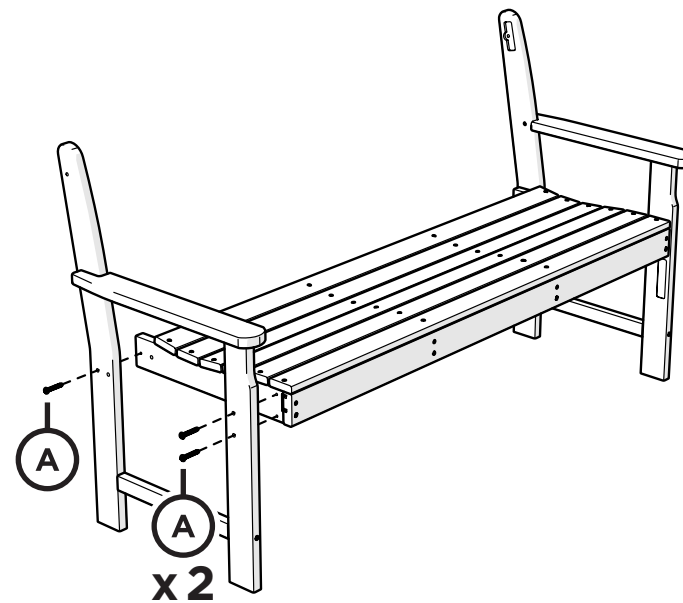

3

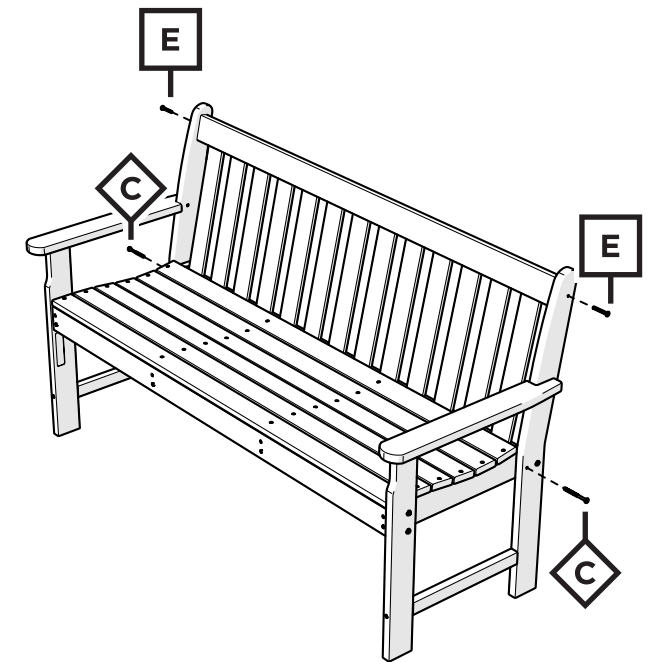

4

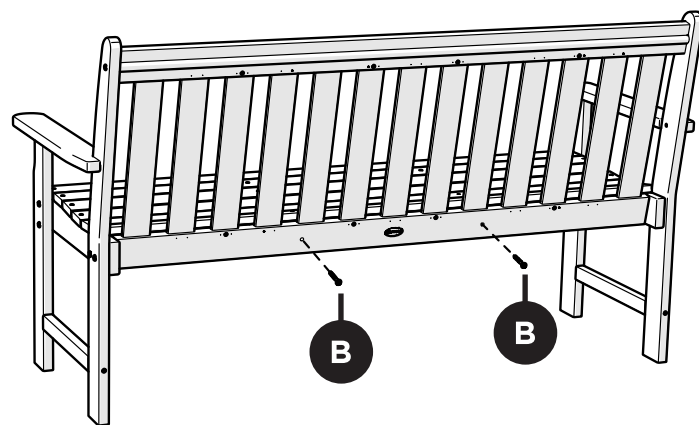

5

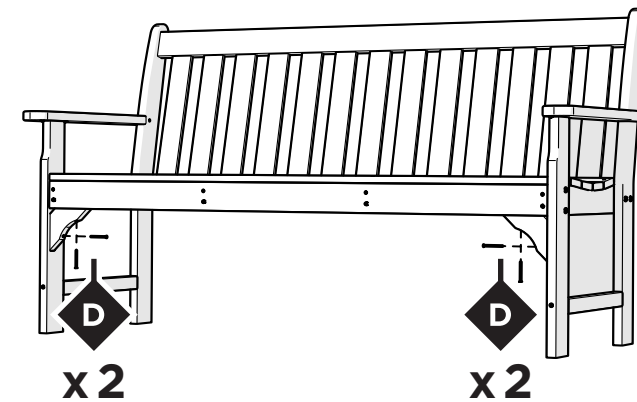

POLYWOOD