

# ***Bend***





# BEND GOODS IS ON A MISSION...

Bend is on a mission to create designs that are superbly crafted, delight you aesthetically, and shape your life. Our philosophy has always been to design pieces that are equally as beautiful as they are functional. These attributes are in the forefront of our minds as we strive to make unexpected products that evolve with our customers.

Our contract grade and BIFMA tested products are versatile enough to fit into any interior or exterior setting. From a residential backyard to a five-star restaurant, Bend pieces can blend seamlessly into the most modern and/or distinctly traditional of spaces. All of our designs are hand bent and spot welded using recyclable metals before being electroplated or powder coated with durable and Eco-friendly materials. For those who want something a little more unique, all of our products are customizable, in both color and design, for us to help you create a made-to-measure piece for your space.

Founded in 2010 by Gaurav Nanda - Bend is a product of his fascination with fusing beauty with utility. Growing up, Nanda was surrounded by creativity with a Mother who made Macramé wall-hangings in her free time and a Father who pursued entrepreneurial endeavors. As he grew older he began to experiment with different mediums in artwork and became obsessed with pottery. Nanda's love of using clay to create stayed with him throughout his life, but as he advanced in his education he encountered a life long dilemma that every 20 something has to confront: getting a job.

Upon graduating from Purdue University, he took a position as an Automotive Sculptor for General Motors. During his time at G.M. he designed and built vehicle models both by hand and by using new computer technology. This aspect of the job allowed him to understand the application of technical functionality to art and design. Sculpture and modeling were no longer just a way to aesthetically express himself, but rather a way to make his imaginative designs a reality. After seven years Nanda found himself at a crossroads: either stay at his job and continue on the corporate track or take a risk and pursue a career in the design world. We bet you can guess what happened...

After deliberating how to apply his technical experience to art and design it struck him: furniture is functional artwork. One year, many prototypes, and a move to Los Angeles later - Bend was born. Those original designs focused on integrating distinct patterns, comfort, and versatility into furniture and accessories made of wire. As we expanded our line from one chair to over thirty products we always stayed true to those original intentions established by Nanda and the founding Bend team.



*The Goods*

**Made For Any Space**



### *Lucy Side Chair*

Elegant, vibrant, comfortable, and durable, are just a few words to describe our Mid-century Modern inspired Lucy Side Chair. Lucy, our most popular wire dining chair, is your girl for any occasion.



### *Swiveling Ethel*

Our Ethel Side Chair that you know and love now has a sister design for those, like us, who just can't sit still. We've outfitted Ethel with a newly designed pedestal base that has a swivel feature giving you a 360 degree view of wherever you are.



### *Stacking Lucy*

This variation of our Lucy Side Chair is the perfect combination of fancy and functional. The Stacking Lucy includes all of the signature details of its predecessor in addition to the ability to stack six chairs atop one another. This space saving design will have you asking for even more Bend Goods!



### *Ethel Side Chair*

As the best friend to our Lucy Side Chair, the Ethel combines a similar sized frame with streamlined details that create an elegant dining chair option. This piece is perfect for minimalist settings that need a comfortable seating option with just a touch of playfulness.





### Captain Chair

Whether you're sailing through rough waters or sitting in a heated poker game on your outdoor patio, our wire Captain chair will give you the confidence to go all in. Her optional upholstered seat pads will give you the comfort to keep the game going all night long.

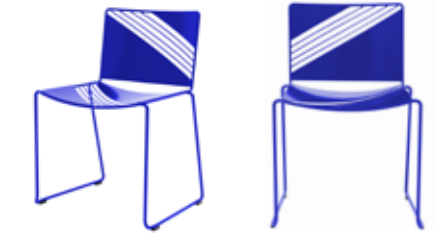

### Cafe Chair

Our newest addition to the line features crisp angles inspired by classic French Cafe furniture and the Memphis movement. The Cafe Chair is perfect for any smaller indoor and outdoor space. This beauty is light and stackable.



### Stacking Betty

Meet Betty, a bohemian chic stacking chair for every occasion. Betty will give you all the beauty you desire without sacrificing any of the space. Use the Betty in a private home or integrate her into a restaurant for an efficient and luxurious stacking option!



### Wood & Wire Chair

That's so retro! Old School meets Bend. The Wood and Wire Chair features our signature wire style with a classic wooden design and vintage vibes. Perfect for any indoor space, this piece will truly stand out. It embodies sophistication and innovation, a one-of-a-kind chair!





## *Hot Seat*

You might be sitting down for an in-depth interview or simply looking for a comfortable lounge chair to have a drink in. Whatever the case may be, the Hot Seat will always keep you cool, calm, and collected.



## *Peacock Lounge*

The Bend Goods Peacock Lounge Chair is our take on the iconic design that was made famous in the 1970's. Unlike its wicker predecessor, our Peacock design is made completely from wire and will last far longer than a single decade.



## *Love Seat*

Love is the name of the game for this modern wire sofa made for two. Good for indoor and outdoor use, home and office alike, its the perfect spot to enjoy a cocktail, a sunset, and a warm summer breeze.

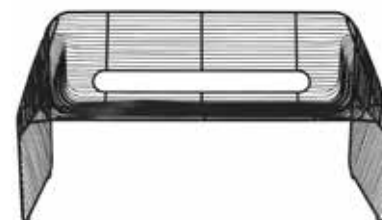

## *Bunny Lounge*

She's sexy yet sophisticated and has more curves than a winding mountain road. The Bunny Lounge is refined wire furniture at its finest with all the comfort you need for any living room or patio.





## *Farmhouse Lounge*

With a backrest inspired by the antique barns of the Pennsylvania Dutch, the Farmhouse Lounge Chair is an architecturally inspired masterpiece. Its extra wide seat makes the Farmhouse the perfect chair to relax in after a long day at the office or on the farm.



## *Lucy Counter & Bar*

With the same striking design as its Side Chair counterpart, the Lucy Bar Stool gives you the height for your modern bar or kitchen counter while maintaining the whimsical elegance of the original design.



## *Cloud Bench*

1970s textile design, featuring repetitive elliptical contours, provided inspiration for the curved back & intersecting lines. The sculptural design of the bench allows the piece to become a functional work of art that is both aesthetically bold and ergonomic.



## *Stacking Lucy Counter & Bar*

As an update to its non-stacking sister chair, the Stacking Lucy Bar Stool gives you the height for your modern bar or kitchen counter while allowing you to stack up to six stools atop one another.



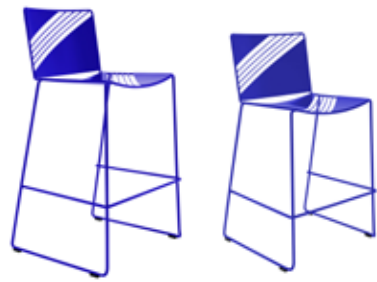

## *Cafe Counter & Bar*

Our newest addition to the line features crisp angles inspired by classic French Cafe furniture and the Memphis movement. The Cafe Counter & Bar Stool are perfect for any indoor and outdoor spaces. These stackable wire stools are light and available in five new standard colors.



## *Sweet Stool*

With an hourglass shaped wire base and fixed wood seat made of solid white oak, the Sweet is a stool for every occasion. Its compact design and ideal seat height make it a stylish space saver that will make any room a bit sweeter.



## *Stick Stool Counter & Bar*

The juxtaposition of the Stick Stool's powder coated steel base with the glow of the honey wood top makes this barstool one of our most intricate pieces yet. Throw a Stick Stool at your counter or bar to provide streamlined seating with subtle wire detailing that will make any guests do a double take.



## *Switch Stool & Table*

The Switch Stool & Table combines versatility with beauty. In its standard form, the Switch features a glass tabletop for use as a side table that showcases its wire form and details. To transform the Switch, add the optional Switch Table/Stool Pad to create an extra place to sit down.







## *Cafe Table*

The Cafe Table is our most compact and versatile dining option yet. Throw a Cafe Table on your patio for a great place to sip your morning coffee or cluster a few tables in a restaurant for a funky place to eat that will keep patrons coming back for more.



## *Cafe Bar Table*

The Cafe Bar Table is Bend's take on the classic two-top dining table popular in Parisian cafes. Like its predecessor, the Cafe Bar Table is the perfect wire bar table for compact dining spaces both residential and commercial alike. No matter where it's placed, this table will have friends and guests coming back for more!



## *Bistro Table*

As Bend's first dining table option, The Bistro Table is everything you could possibly need for a casual dining experience. Its wire base makes for a solid design that will hold up to any wild dinner party you throw. Try the Bistro Table with a Powder Coated Metal table top or dress it up with the Marble table top.



## *Cono Side Table*

The Cono Side Table is comprised of a wire base with a fixed sheet metal tray table top. The Cono's compact base makes it a great side table solution for design lovers living or working in compact spaces.





### *Wave Table*

Sometimes you just have to go with the Wave(s)! This unique piece, crafted with sheet metal is for all design lovers who want a table as wild and free as the ocean. It comes with a glass table top and will definitely add Beach Vibes to your living room space.



### *Terrazzo Table*

The Terrazzo Table features the distinctive character of the metal wire base paired with a fresh take on retro terrazzo. Made of natural stone and recycled iron, this side table is both versatile and environmentally sustainable.



### *Coffee Table*

With a large table top and even sexier base, the Coffee Table will make any space instantly more efficient and better looking. With glass and marble table top options, this piece can fit into both casual and formal setups. Incorporate it into your space to see just how beautiful this wire piece can be in your home.



### *Drum Table*

The Drum Table is the definition of wire furniture versatility. Put this wire end table out by the pool to keep your sunscreen at reach or add a cushion and kick up your feet for movie night. Indoor or outdoor, there's really no place this end table can't go.





### Macramé Art Piece

The Macramé Art Piece is a hand crafted design made locally, right here in Los Angeles. Each unique design combines our Modular Art Piece with elegantly woven yarn, giving it that genuine look of craftsmanship. Inspired by the bright colors and wild patterns that shaped 70's art, The Macramé Art Piece adds a touch of creativity to any space.

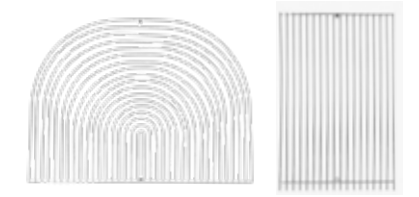

### Modular Art Piece

The Art Piece uses our signature metal wire formed into two separate pieces, curved and straight, for a flexible arrangement. The interactive design allows you to arrange the pieces any way you'd like to create your own unique sculptural design for your walls.



### Baskets

Bend Wire Baskets give you all the functionality and versatility of the African market baskets they are inspired by. As with the rest of the goods, these wire accessories maintain a strong sense of color and detail that adds personality to any modern home.



### Array & Mini Pendant

Whether glittering in copper over your dining room table, or adding a pop of color to your bedroom, the Bend Array Pendant light is the wire lighting to class up any space.



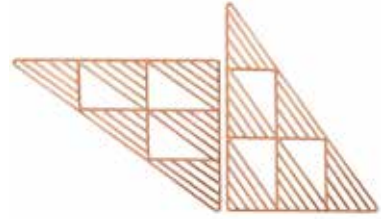

## Triangle Brackets

Metal shelving brackets aren't often associated with fun and modern design. Our Triangle Brackets redefine the standard by incorporating Bend's signature geometric design patterns. These brackets will give your shelves some much needed style and support.

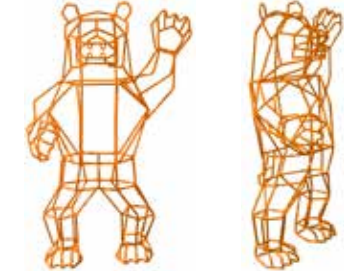
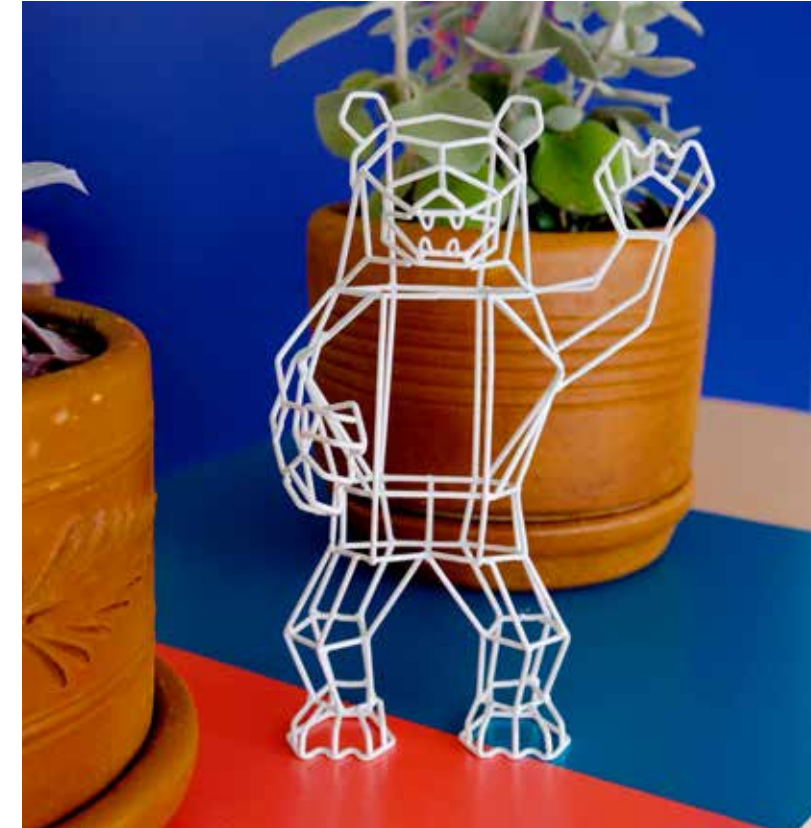

## Marching Bear

The Marching Bear represents Bend's passion for social progress and 'marching' forward towards positive change. This little guy represents Bend's passion for the environment and love for charitable action!



## Plant Stand

Just like any well planned outfit, sometimes you just need a great accessory to pull it all together. Think of the Bend Goods Plant Stand as the perfect accent to dress up your potted plants and add a little drama to any floral grouping.



## Trophies

Have you ever dreamed of going on safari or trekking through the frozen tundra? Well now you can bring the adventure home with our geometric wildlife wall art. It's the easiest way to feature a trophy head in your home with no hunting necessary!

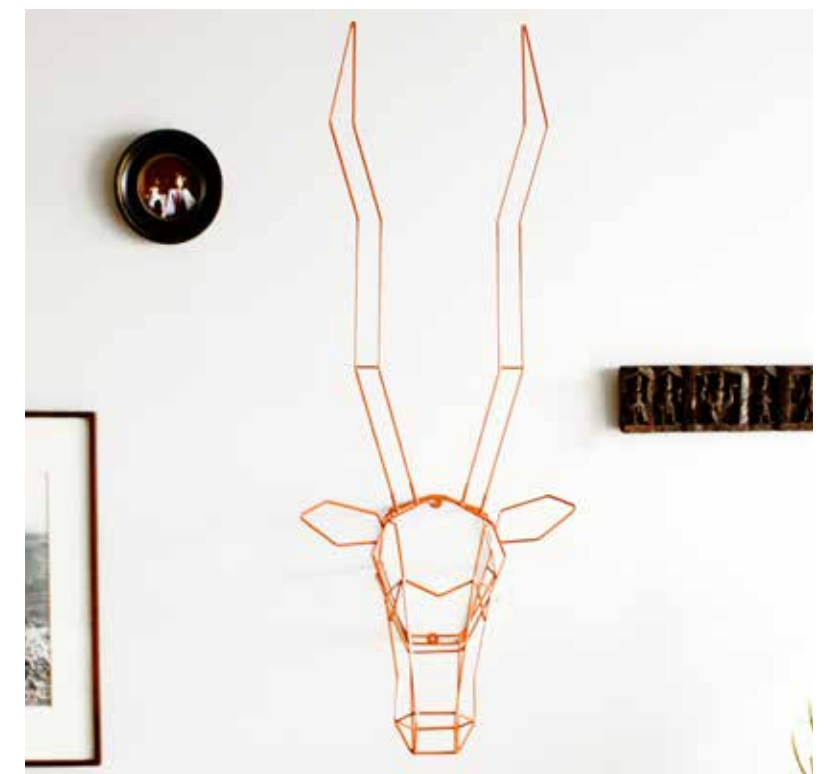
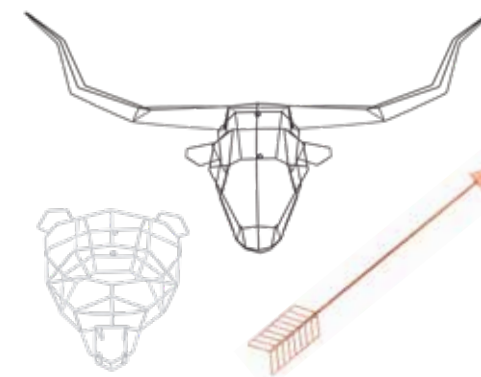



*Padding*



## *Throw Pillows & Pads*

We designed our Throw Pillows to be the ultimate accessory for your home. Filled with down and available in a multitude of durable Sunbrella Fabric options to take your space to the next level.  
Made in Los Angeles.



## *Leather Saddle*

Every cowboy needs a good saddle. Hand-made from 100% cowhide leather, the Lucy Saddle Pad is the perfect modern accessory for the urban cowboy inside us all.



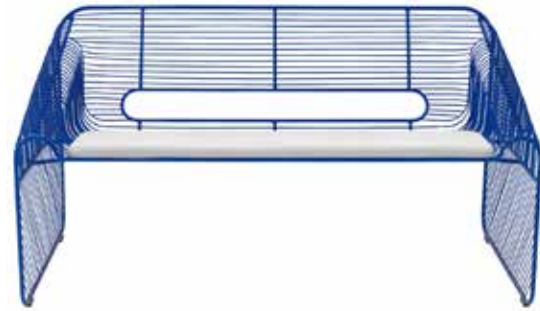

### *Love Seat Pad*

To add a little extra love to this already comfy piece, we designed the Love Seat Pad. Covering the entire seat from end to end, this pad will give you and your companion a little more comfort to love.



### *Hot Seat Pad*

Take some of the heat off your seat with the Hot Seat Pad. This single stitch pad option adds a little comfort where you need it most.



### *Betty Pad*

To add a bit cushion to your Betty Chair, try the Betty Pad! This padding option is specially designed to fully fit the curves of the Betty Chair.



### *Switch Pad*

Take the Switch a step further and add on the optional Switch Table / Stool Pad. Start with the vegan leather table top side up for a compact side table solution. Then switch sides to the padded seat with the perfect cushion for your bum.



### *Peacock Pad & Pillow*

When you have a chair like our Peacock Lounge, adding padding without distracting from the design can be tricky. To prevent this, we designed an oversized low-profile seat pad paired with our Round Throw Pillow to provide comfort and to accent the wire detailing.



### *Swiveling Ethel Pad*

We've outfitted Swiveling Ethel with a full seat pad. Covering the entire seat area, the Ethel Pad adds great comfort to an already comfortable chair. Making 360 degrees that much more sexy.



### *Captain Cover-Up*

Our Captain Cover-up adds a lot of comfort without compromising any style. With detailed stitching mimicking it's wire lines and the back left completely exposed, the Cover-up is a surprise around every corner.



### *Captain Bikini*

If you want to add a little extra comfort to the Captain Chair, but don't want to cover up any of her signature wire curves, the vegan leather, upholstered Bikini Seat Pad is for you. Featuring a triangular back support and quilted seat pad, the Bikini will have you ready to relax away the day in the Captain Chair.

*Projects*



**Bavel**  
*Los Angeles, CA*





**Residence**  
*Nashville, TN*

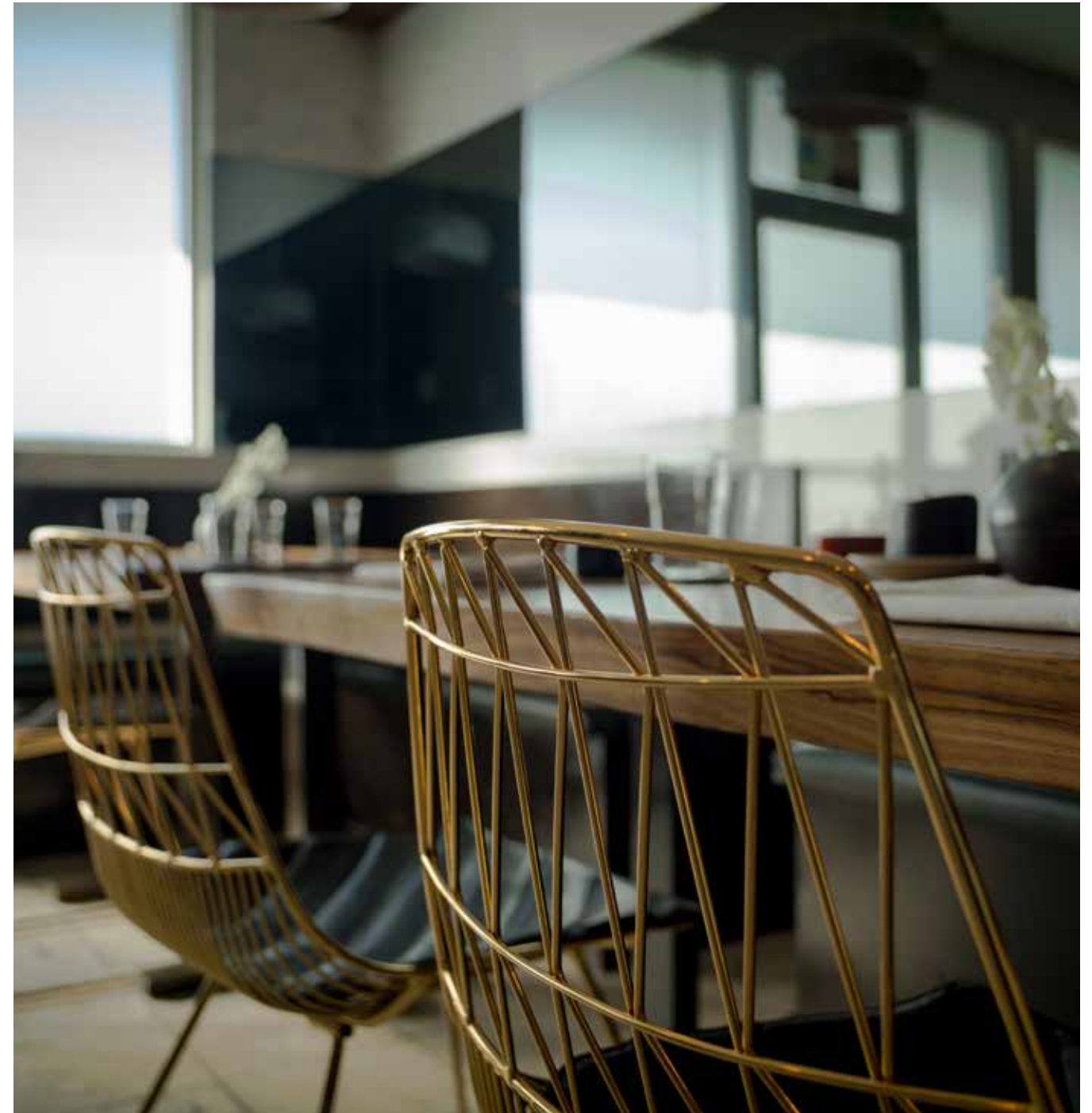

**Trois Mec**  
*Los Angeles, CA*



**Campfire**  
*Carlsbad, CA*

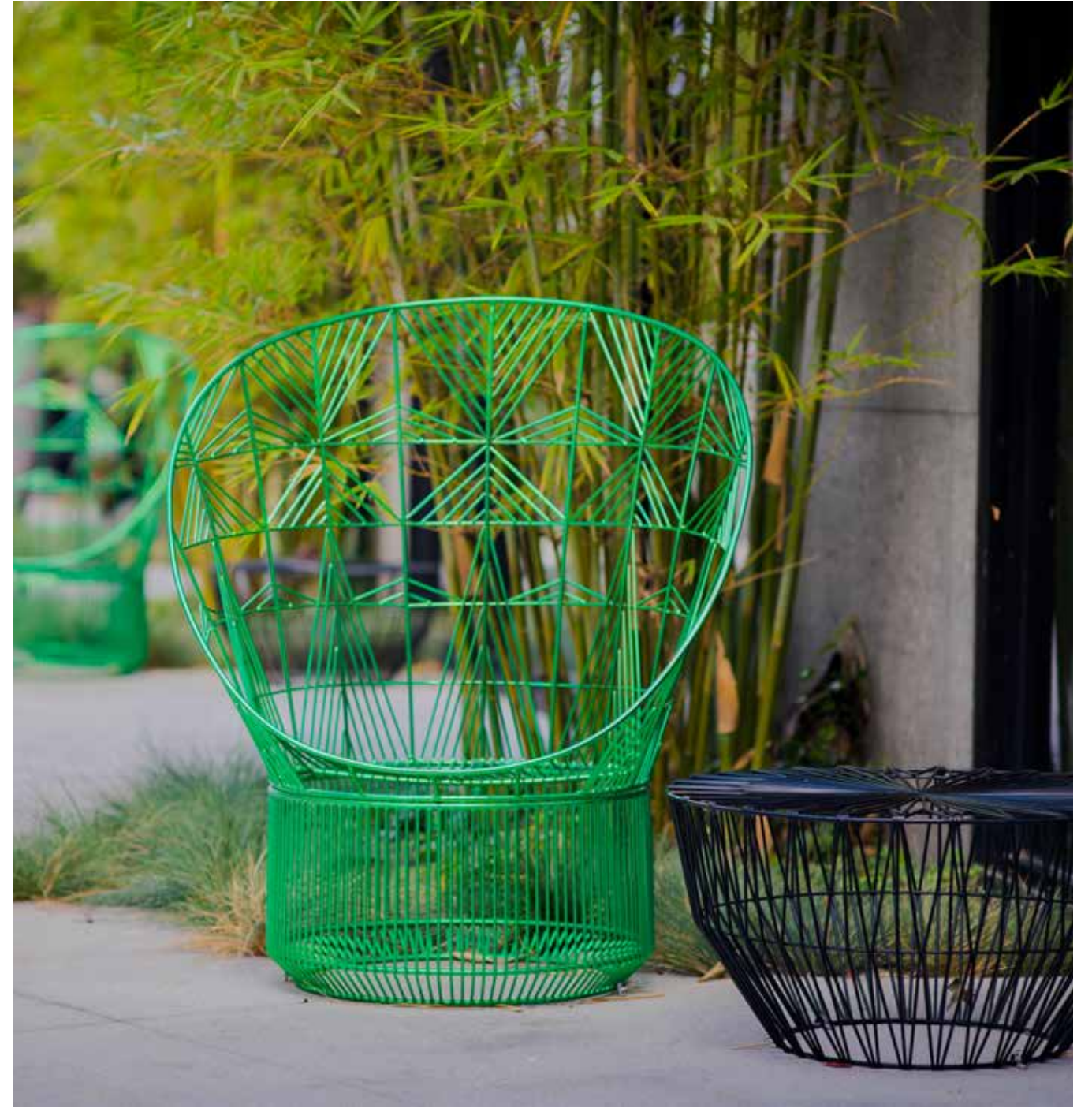

**Platform**  
*Los Angeles, CA*

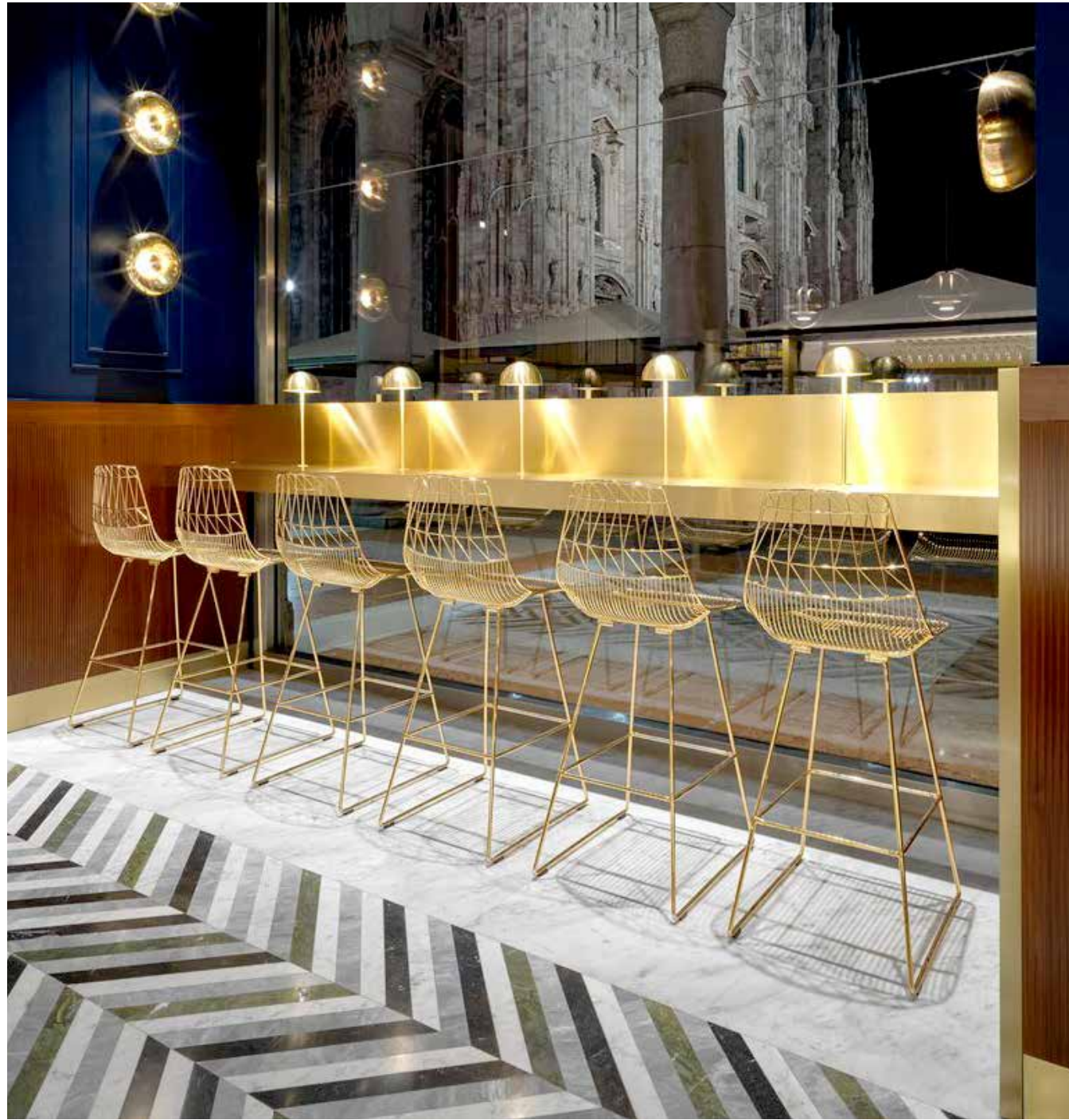

**Motta Milano 1928**  
*Milan, Italy*

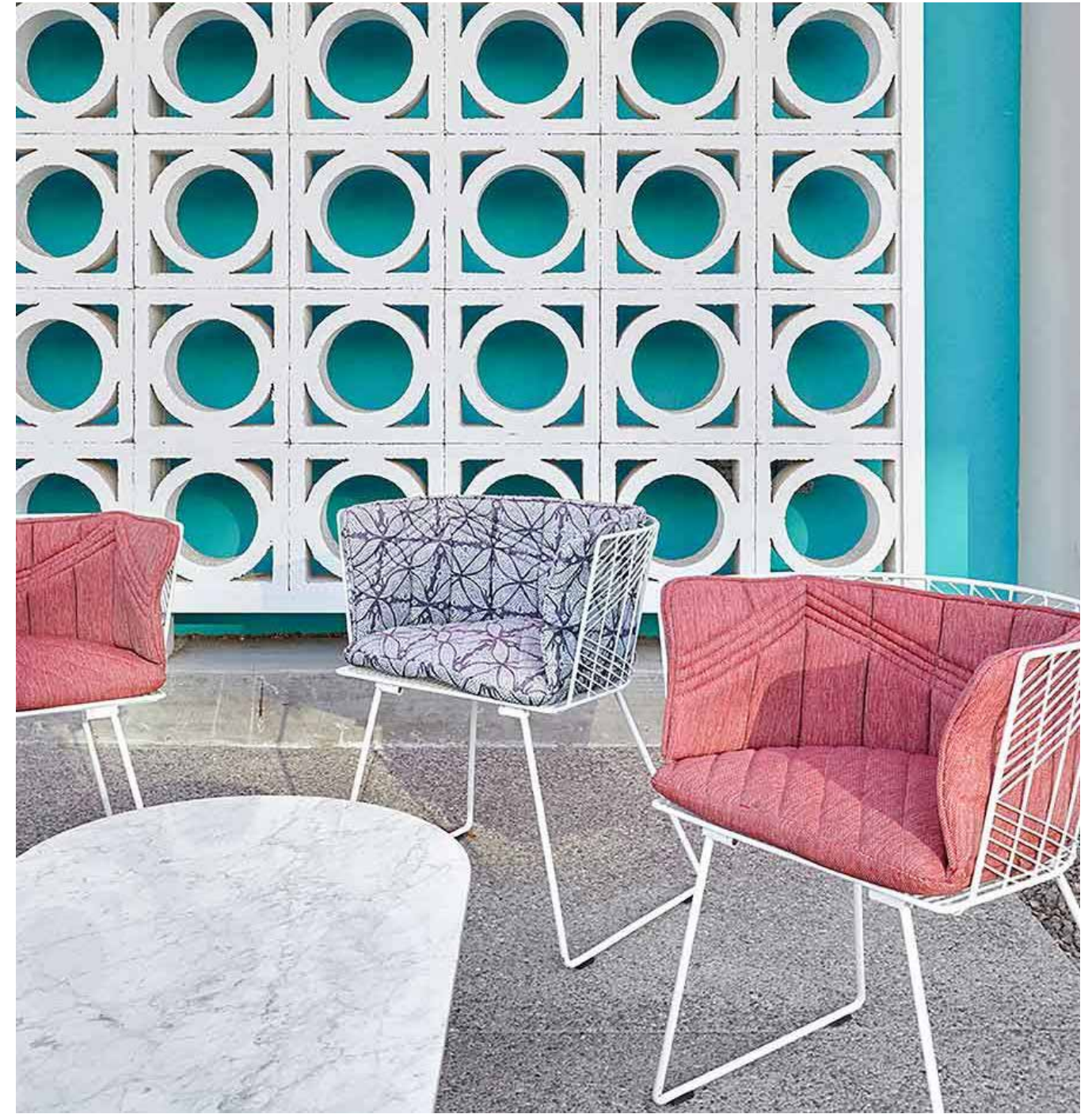

**Mountain Shadows Resort**  
*Scottsdale, AZ*



**Workshop Kitchen & Bar**  
*Palm Springs, CA*



**Bavel**  
*Los Angeles, CA*



*Features & Finishes*



## Features

### Indoor & Outdoor

Our powder coated finishes are manufactured for both indoor and outdoor environments. We have taken every measure to prevent corrosion by employing a galvanization process where our products are zinc coated before they are powder coated, adding an extra layer of durability. All of our chairs are also outfitted with glides to prevent friction with the ground.

### Sustainable & Responsible

We are committed to minimizing our environmental impact by employing responsible manufacturing practices. We use metal, which is highly recyclable, and have designed our packaging to ship multiple products per box to minimize our carbon footprint. Due to these factors, our products contribute to LEED certification.

### Today & Tomorrow

In today's world, the consumption of products is increasing at an alarming rate while the life span of those products is decreasing. In many cases furniture has become a disposable item. At Bend, we focus on the longevity of our designs both aesthetically and structurally. This allows us to fight the problem rather than contributing to it.



## How It's Made

### Handcrafted

Our chairs are comprised of intricate wire patterns formed through a method of hand shaping and spot welding. We refer to this process as "bending." Each bend is carefully made to achieve the utmost structural support, while the angles of the back, the curvature of the seat, and the distance between the wires are designed to promote comfort and utility.

### Comfort

When anyone sits in our chairs, the first thing we typically hear is "Wow, this is so comfortable!" Bend designs are intricate not only for aesthetics, but also for utility. The wires are welded close together so that every chair has unique strength, comfort, and just the right amount of rigidity.

### Built Like a Buffalo

We are certified for BIFMA (Business + Institutional Furniture Manufacturers Association) 2012 standards, a formal test conducted by an independent third party to review construction and weight capacity. Our chairs are contract grade and perform well in high traffic areas.



## *Materials*

### **Iron for Mild Environments**

Most Bend products are made of iron. The iron is hand shaped and spot welded to create the initial design and shape of each product. We then sandblast the metal to clean away any imperfections. Galvanization or the application of DuPont fluorocarbon makes the iron more durable and suitable for outdoor environments. Though our products are durable, the lifespan of the finish can vary depending on the environmental conditions of the setting. Our iron products are meant for mild environments where the products do not sit in precipitation for long periods of time. If pieces are exposed to the elements, we recommend wiping the item(s) clean of any moisture.



### **Stainless Steel for Coastal Environments**

Climates with high levels of humidity and/or constant moisture from rain or sea spray can be toxic to outdoor furniture. For these harsher environments, our products can be constructed using stainless steel. Stainless steel is a combination of iron, chromium, nickel, manganese, and copper that stands up to corrosion and degradation in moisture heavy climates. This upgrade is the best way to keep our Goods looking their best for generations to come.



## *Outdoor Finishes*

### **Gem Tones**

Unlike our Metallic finishes, the Gem Tone finishes are suitable for both indoor and outdoor use. These brilliant finishes are created from a three part process. First, we galvanize the raw iron frame and plate the metal with gold. Next, a translucent powder coat is applied that provides color while keeping the luster of the gold plating visible. The Gem Tone finishes come in four colors: Sapphire (Blue), Emerald (Green), Rubellite (Raspberry), and Amethyst (Purple.) These finishes are as durable as they are stunning!



### **Powder Coating & Custom Colors**

We powder coat our products to make them as durable as possible. Our powder coaters use Tiger and DuPont powder coating materials to create the finishes for all Bend pieces. These finishes are VOC free certified and are completely customizable. If our standard powder coated finishes don't pique your interest, you can select any Ral color to create a custom color finish. Ask about custom finishes and let us make your dream a reality!



### **Neon Colors**

One of Bend's most vibrant color options yet is our electrifying new Neon Color line. To achieve the bold neon colors we implement a two part powder coating process. We begin by applying a White powder coated base color to provide a crisp undercoat followed by the powder coated neon color for a vibrant finish. The Neon Color line is available in four options: Yellow, Red, Green, and Pink.



## *Indoor Finishes*

### **Metallics**

Our plated metallic finishes are the best way to take your interior design from modern and cool to chic and glamorous. Whether gold copper or chrome, these finishes, meant for indoor use only, will give your space enough shine to last a lifetime.





*Index*



SIDE CHAIRS

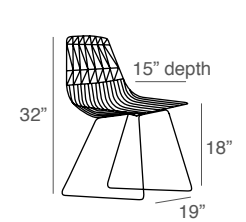

LUCY  
SIDE CHAIR

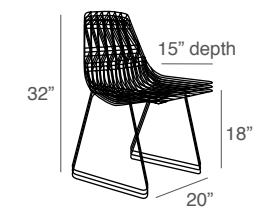

STACKING  
LUCY CHAIR

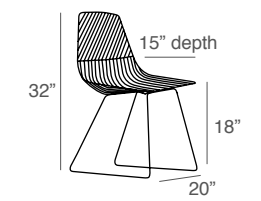

ETHEL  
SIDE CHAIR

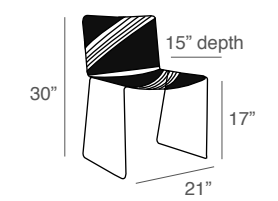

CAFE  
CHAIR

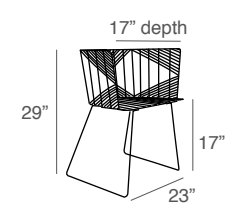

CAPTAIN  
CHAIR

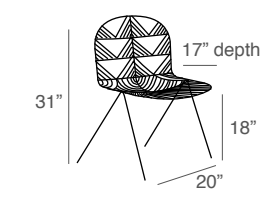

STACKING  
BETTY

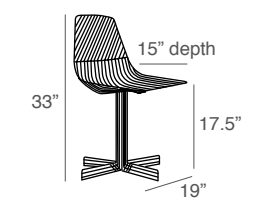

SWIVELING  
ETHEL

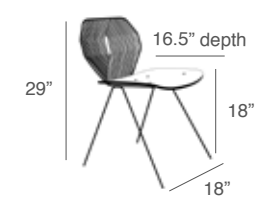

WOOD & WIRE  
CHAIR

LOUNGE CHAIRS

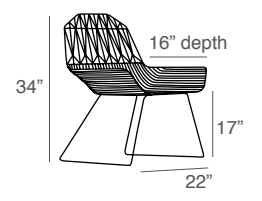

FARMHOUSE  
LOUNGE

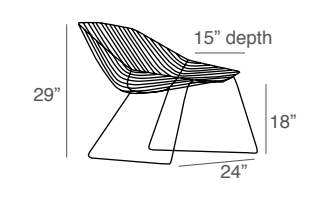

BUNNY  
LOUNGE

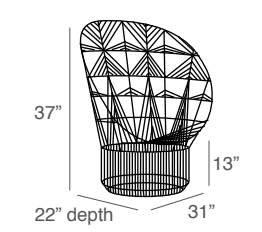

PEACOCK  
LOUNGE

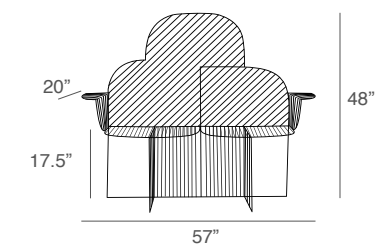

CLOUD BENCH

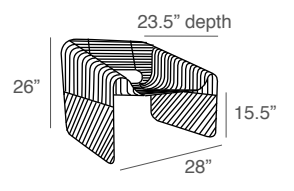

HOT SEAT  
LOUNGE

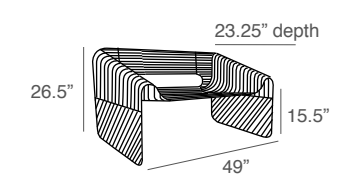

LOVE SEAT  
LOUNGE

STOOLS

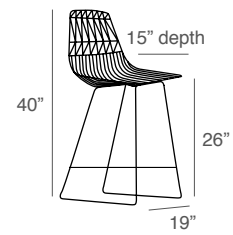

LUCY  
COUNTER STOOL

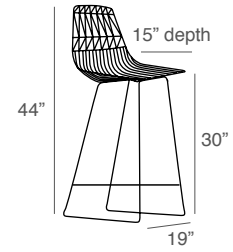

LUCY  
BAR STOOL

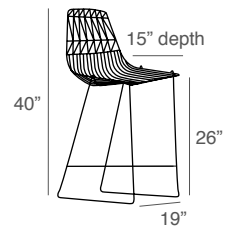

STACKING LUCY  
COUNTER STOOL

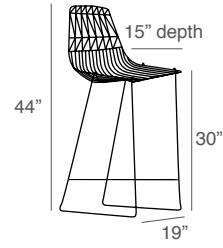

STACKING LUCY  
BAR STOOL

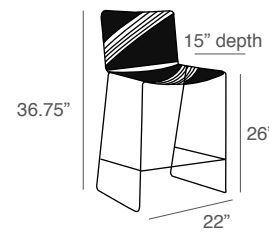

CAFE  
COUNTER STOOL

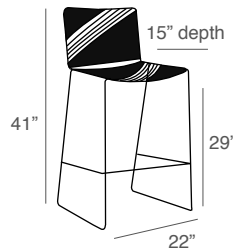

CAFE  
BAR STOOL

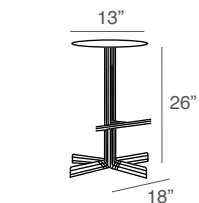

COUNTER  
STICK STOOL

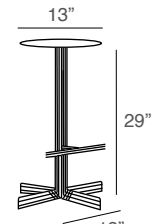

BAR  
STICK STOOL

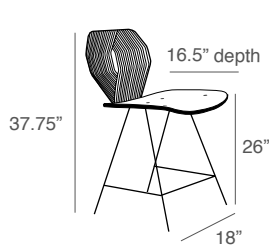

WOOD & WIRE  
COUNTER STOOL

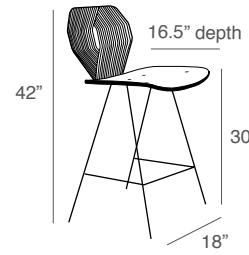

WOOD & WIRE  
BAR STOOL



SWITCH  
STOOL

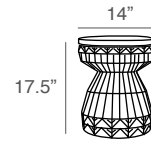

SWEET  
STOOL

MODULAR ART PIECES

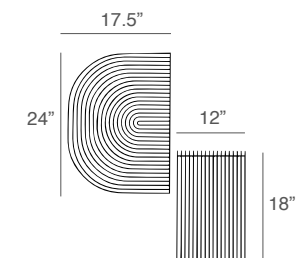

MODULAR ART  
PIECES

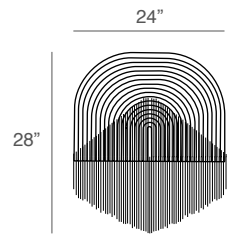

MACRAME ART  
PIECE

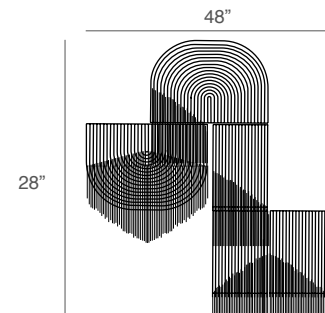

CUSTOM  
MACRAME ART  
PIECE

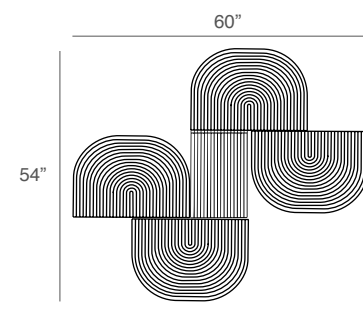

CUSTOM  
MACRAME ART  
PIECE

TABLES

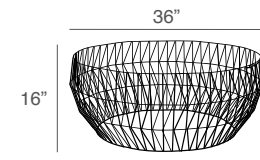

36" COFFEE  
TABLE



WAVE  
TABLE



TERRAZZO  
SIDE TABLE

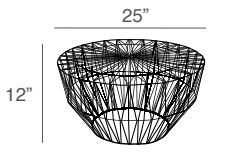

DRUM  
TABLE

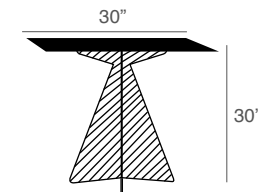

CAFE TABLE  
SQUARE TOP

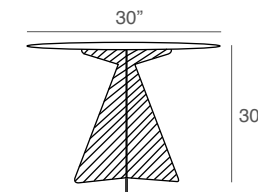

CAFE TABLE  
ROUND TOP

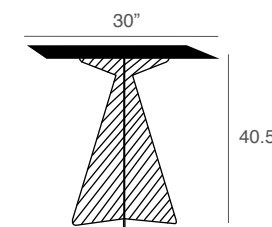

CAFE BAR TABLE  
SQUARE TOP

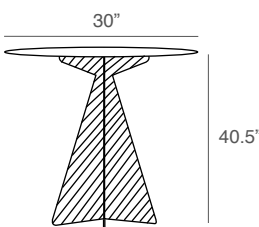

CAFE BAR TABLE  
ROUND TOP

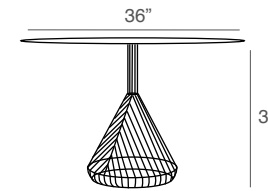

BISTRO  
TABLE

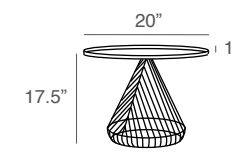

CONO  
SIDE TABLE

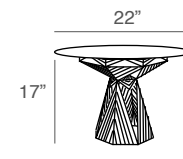

SWITCH  
SIDE TABLE

MODULAR ART ARRANGEMENTS

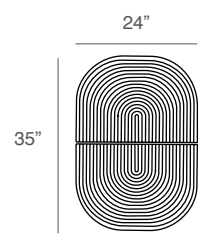
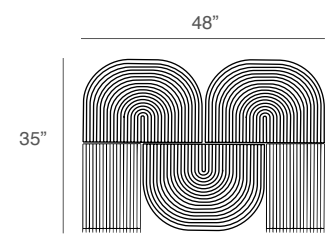
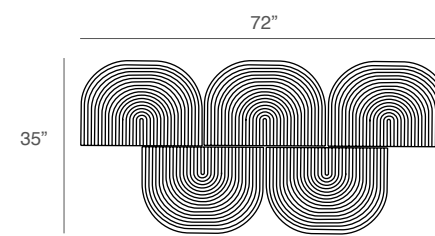
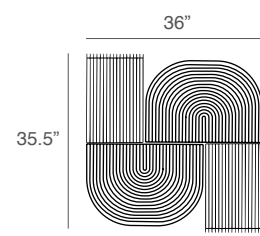

ACCESSORIES

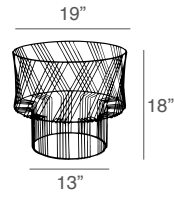

PLANT STAND

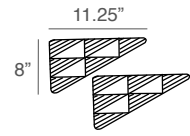

TRIANGLE BRACKETS

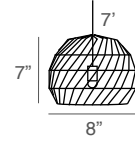

MINI PENDANT

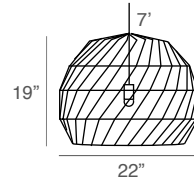

ARRAY PENDANT

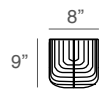

8" MINI BASKET

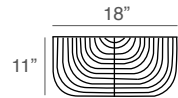

18" BASKET

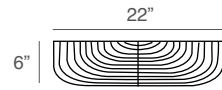

22" BASKET

TROPHIES

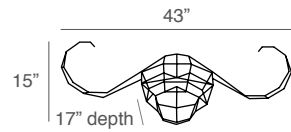

PAPA BUFFALO

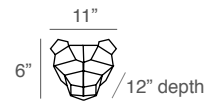

CUB

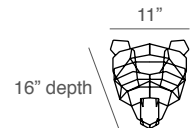

POLAR BEAR

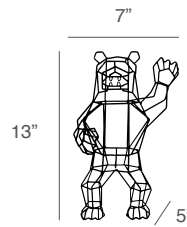

MARCHING BEAR

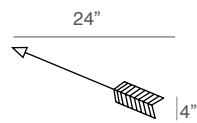

WALL ARROW

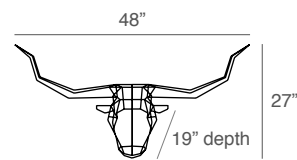

LONG HORN

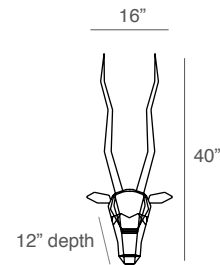

GAZELLE

PADDING

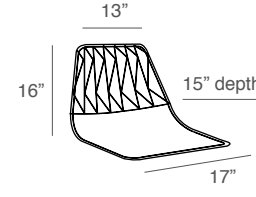

LEATHER SADDLE

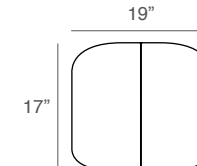

BETTY SEAT PAD

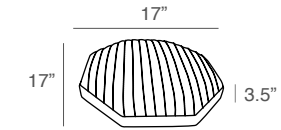

SWITCH SEAT PAD



SUNBRELLA SEAT PAD

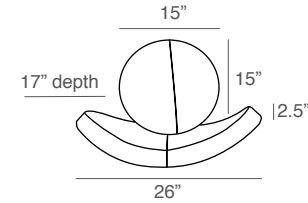

PEACOCK PAD & PILLOW

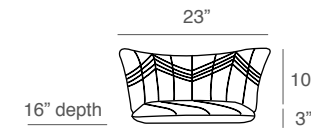

CAPTAIN COVER-UP

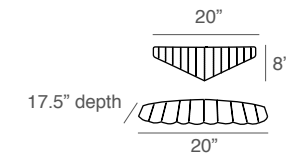

CAPTAIN BIKINI

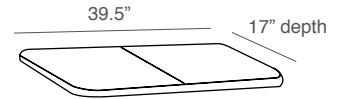

LOVE SEAT PAD

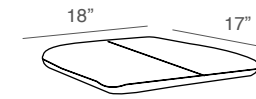

HOT SEAT PAD

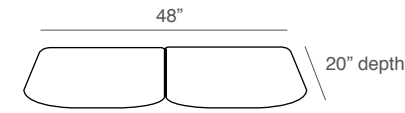

CLOUD BENCH SEAT PAD

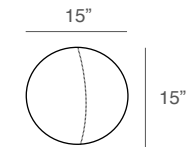

ROUND THROW PILLOW

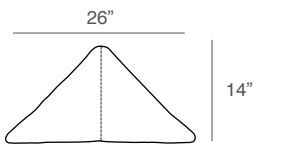

TRIANGLE THROW PILLOW

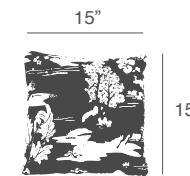

MODERN TOILE PILLOW



**BENDGOODS.COM**

*Let's Connect*

   @bendgoods  
info@bendgoods.com

*Showroom*

7007 Melrose Avenue  
Los Angeles, California 90038  
310.265.3939